

Typical Horizontal Fixing Detail

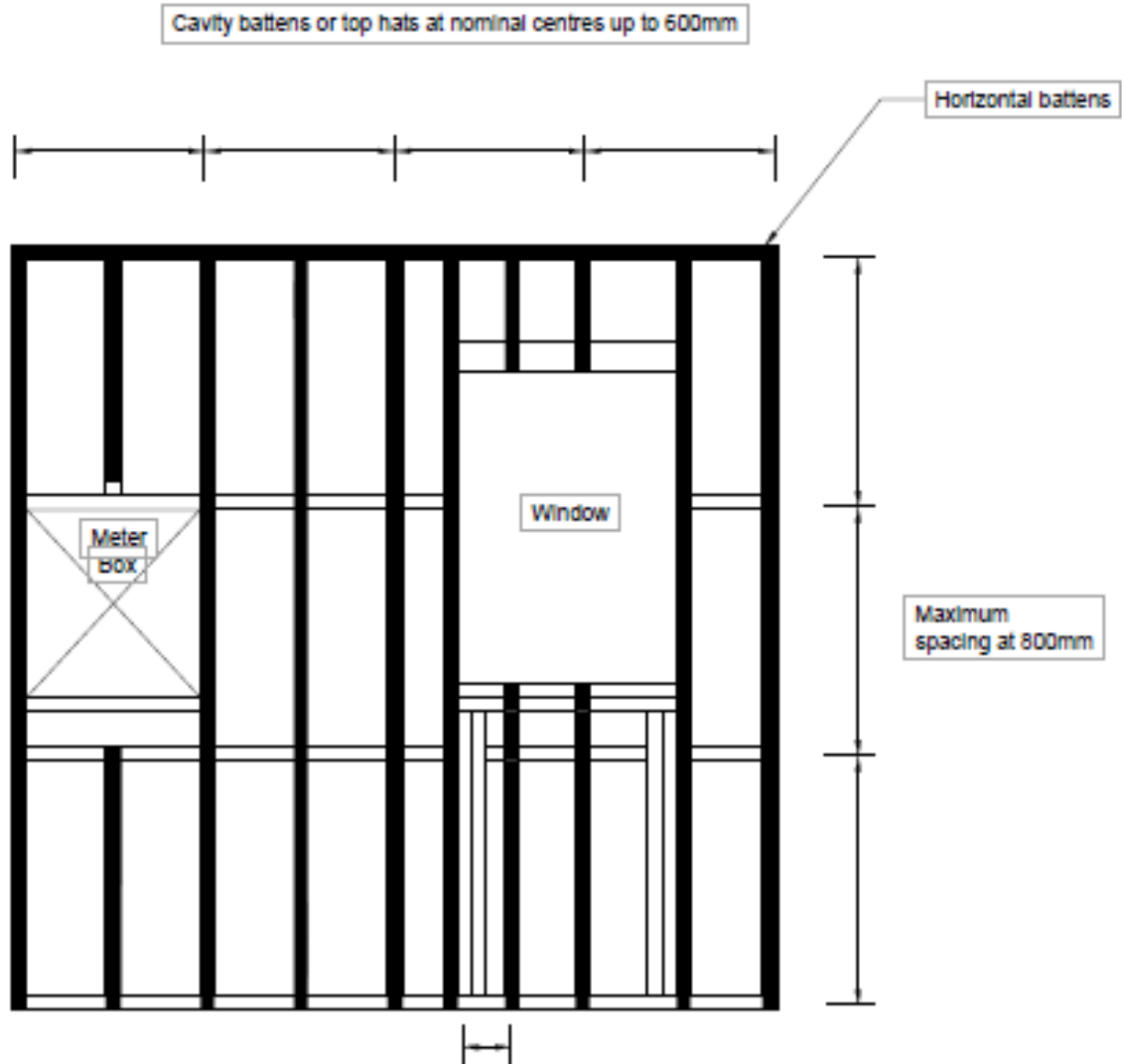

Horizontal Cladding Layout

Typical Horizontal Fixing Detail

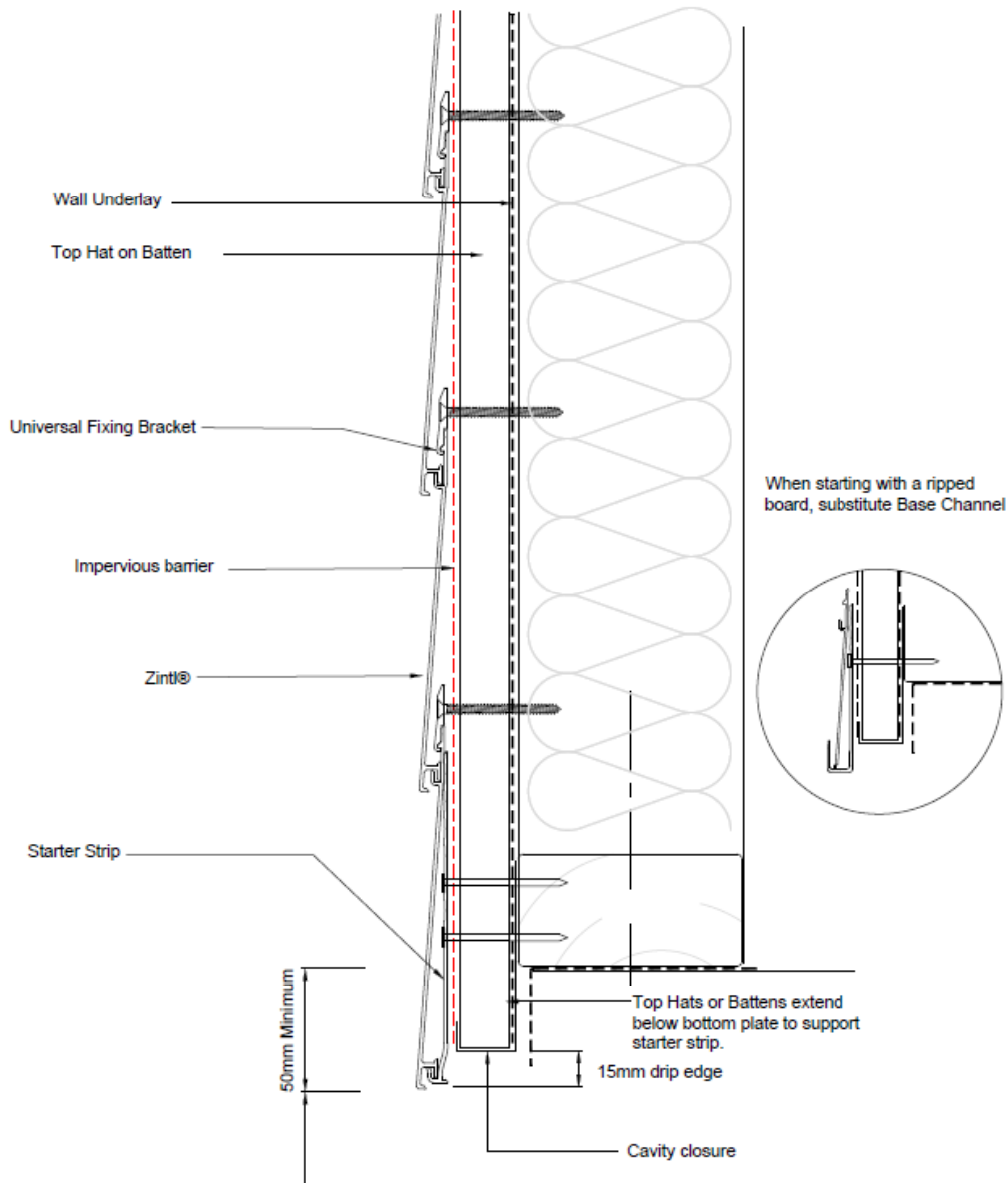

Horizontal Cladding Wall Starter

Typical Horizontal Fixing Detail

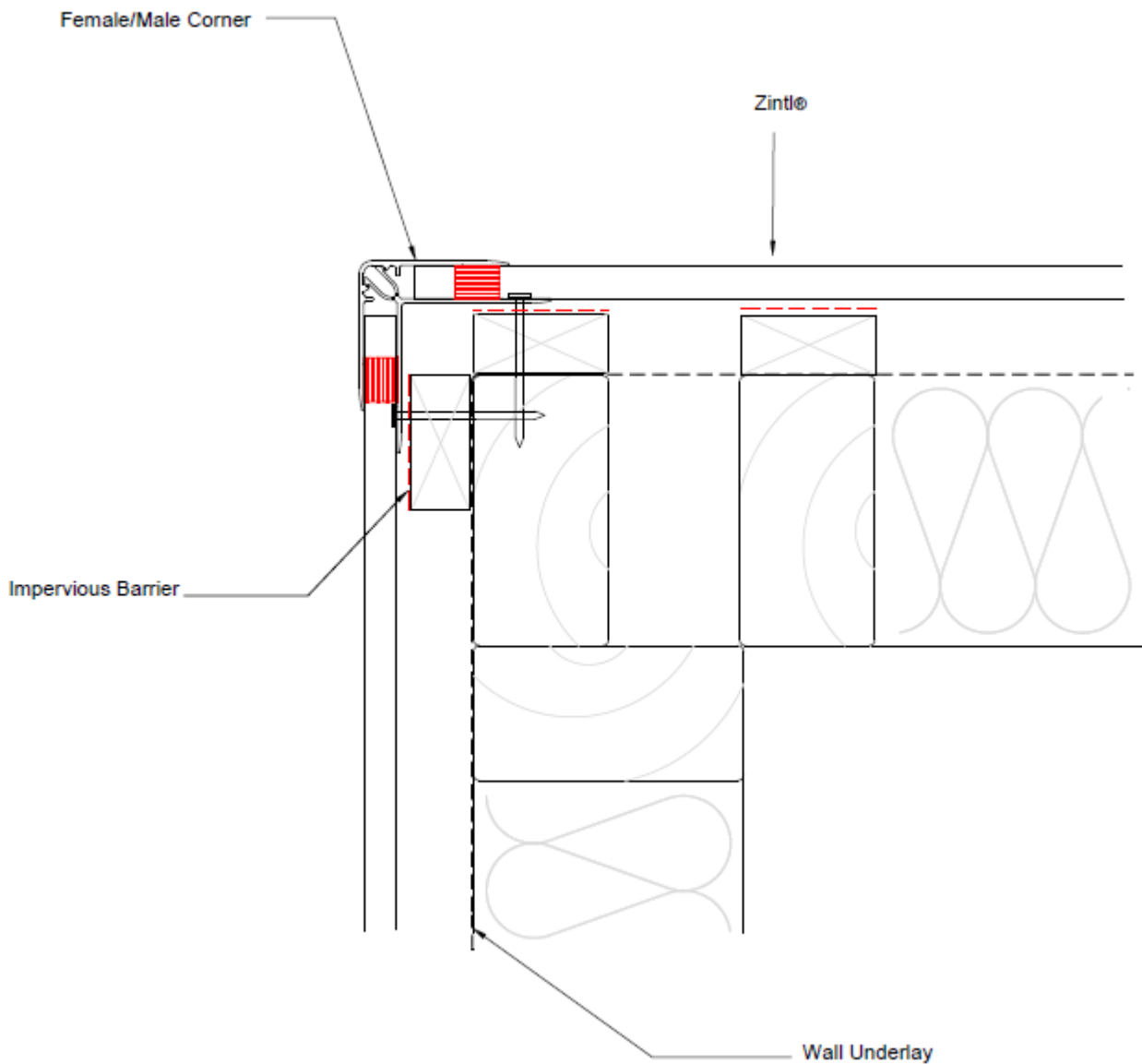

Horizontal Cladding - External Corner

Typical Horizontal Fixing Detail

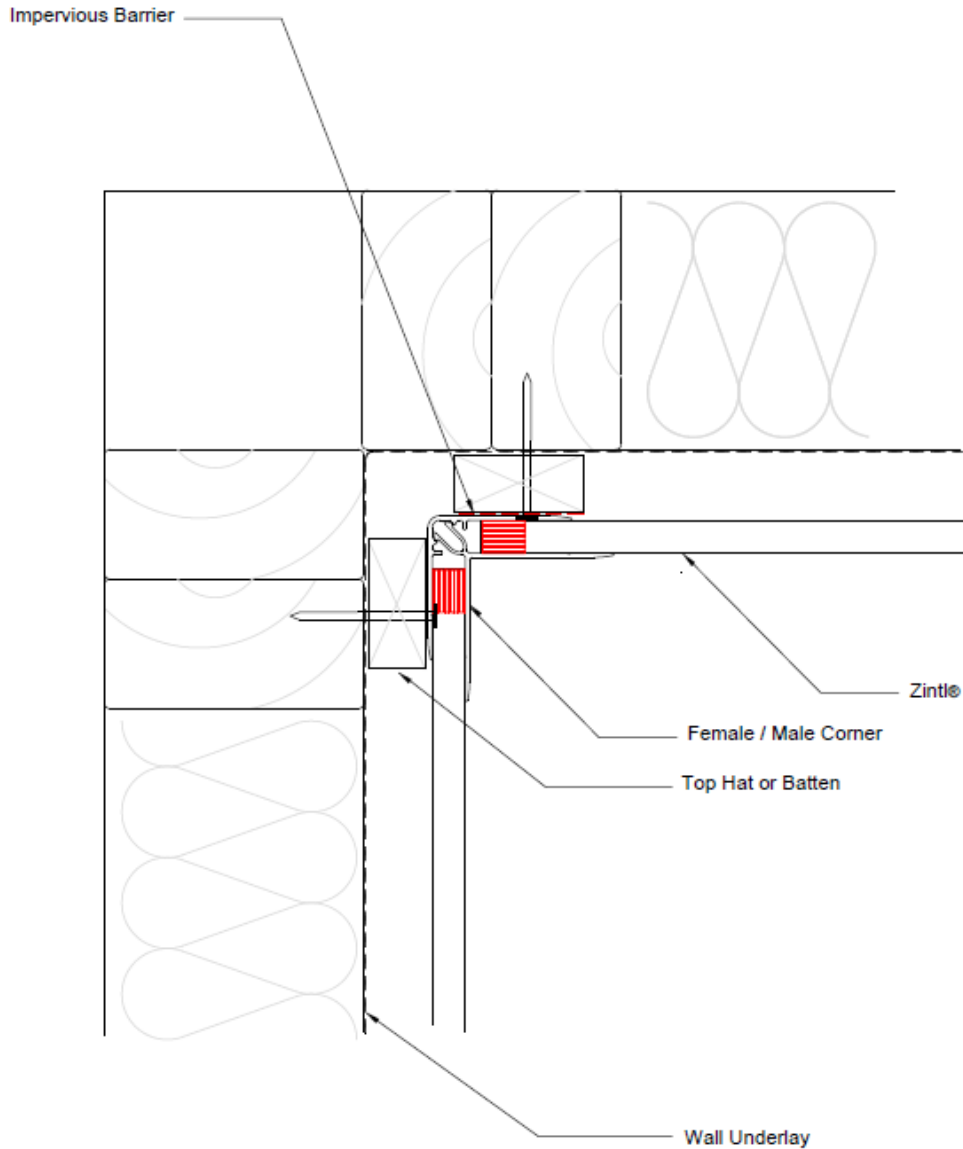

Horizontal Cladding Internal Corner

Typical Horizontal Fixing Detail

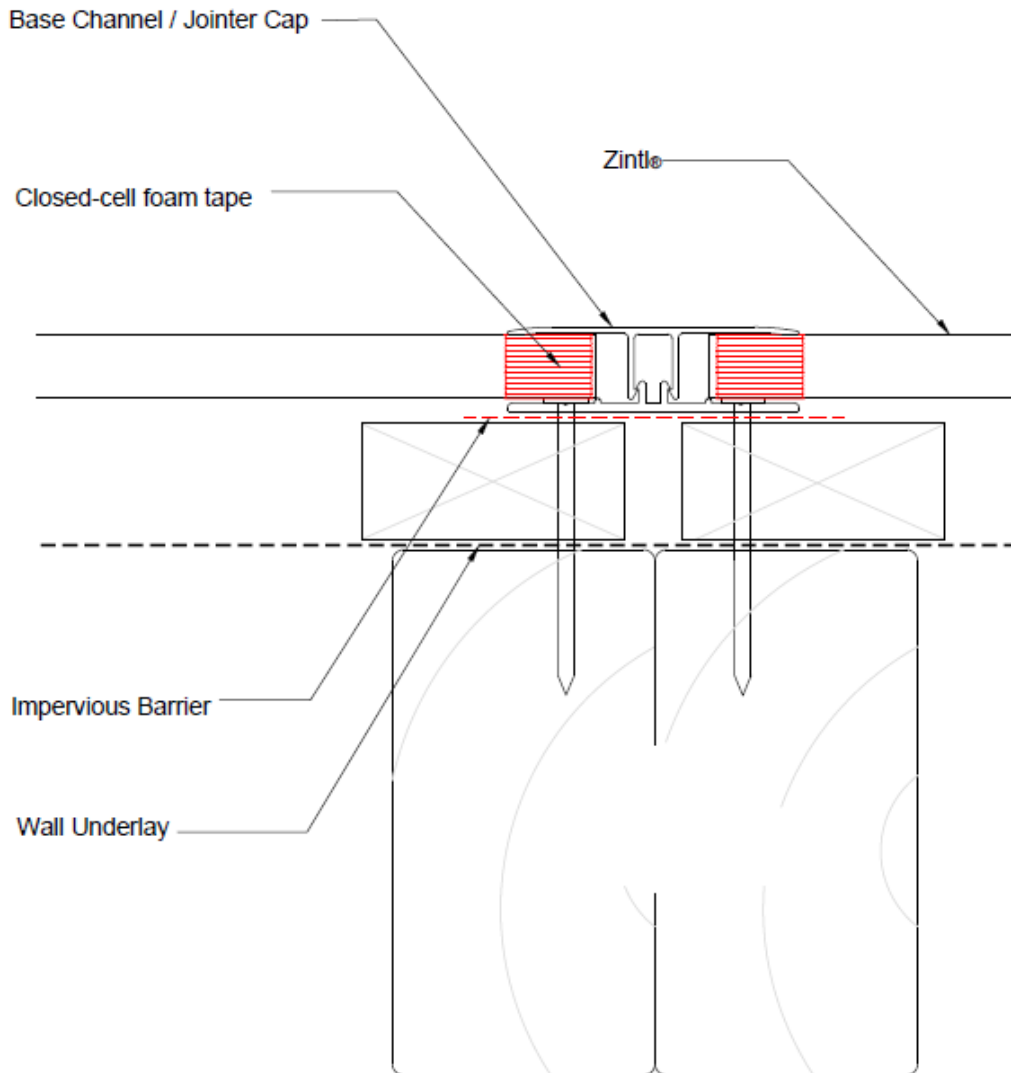

Horizontal Cladding Vertical Joint

Typical Horizontal Fixing Detail

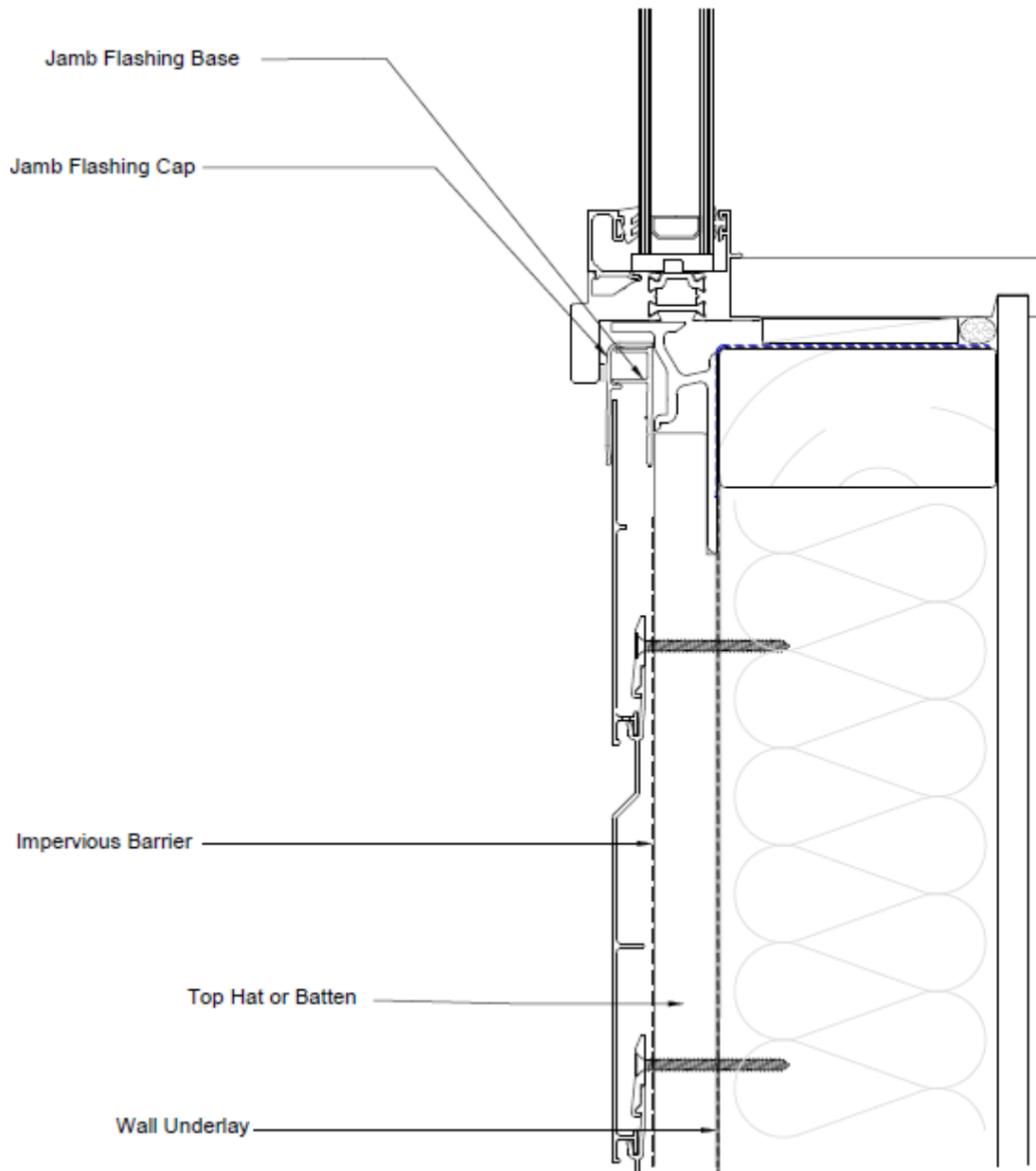

Horizontal Cladding – Sill Detail

Typical Horizontal Fixing Detail

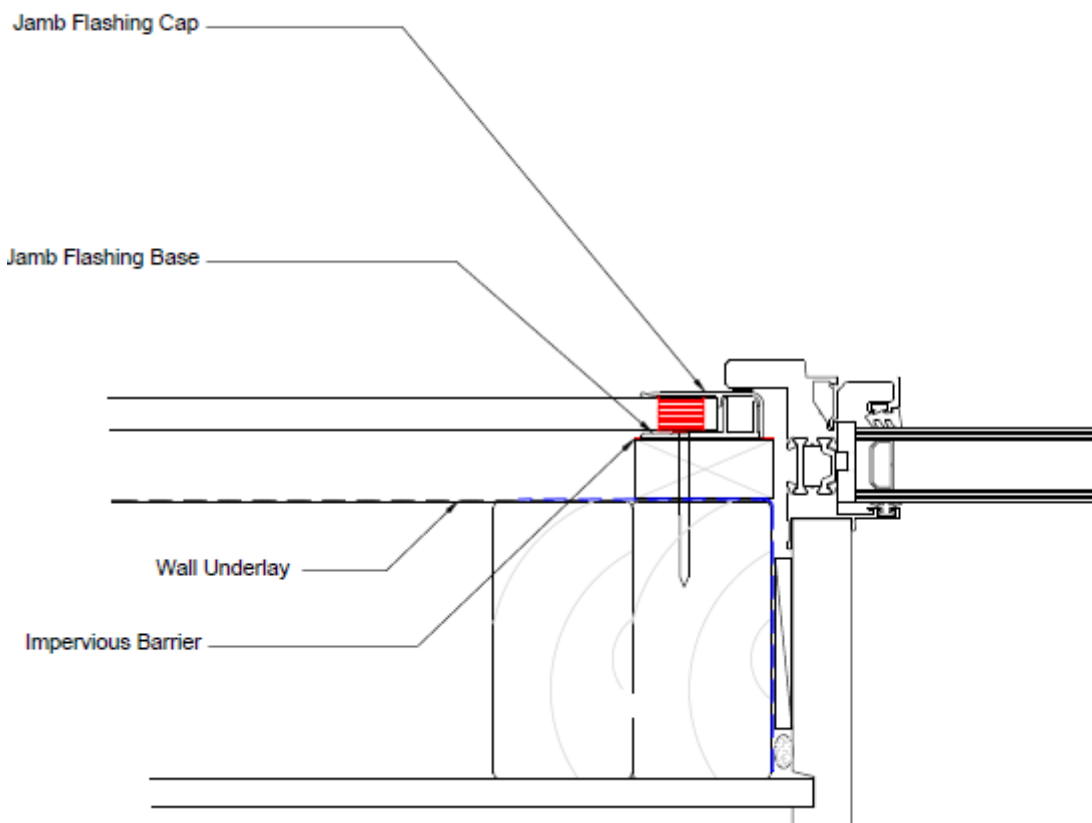

Horizontal Cladding - Window Jamb

Typical Horizontal Fixing Detail

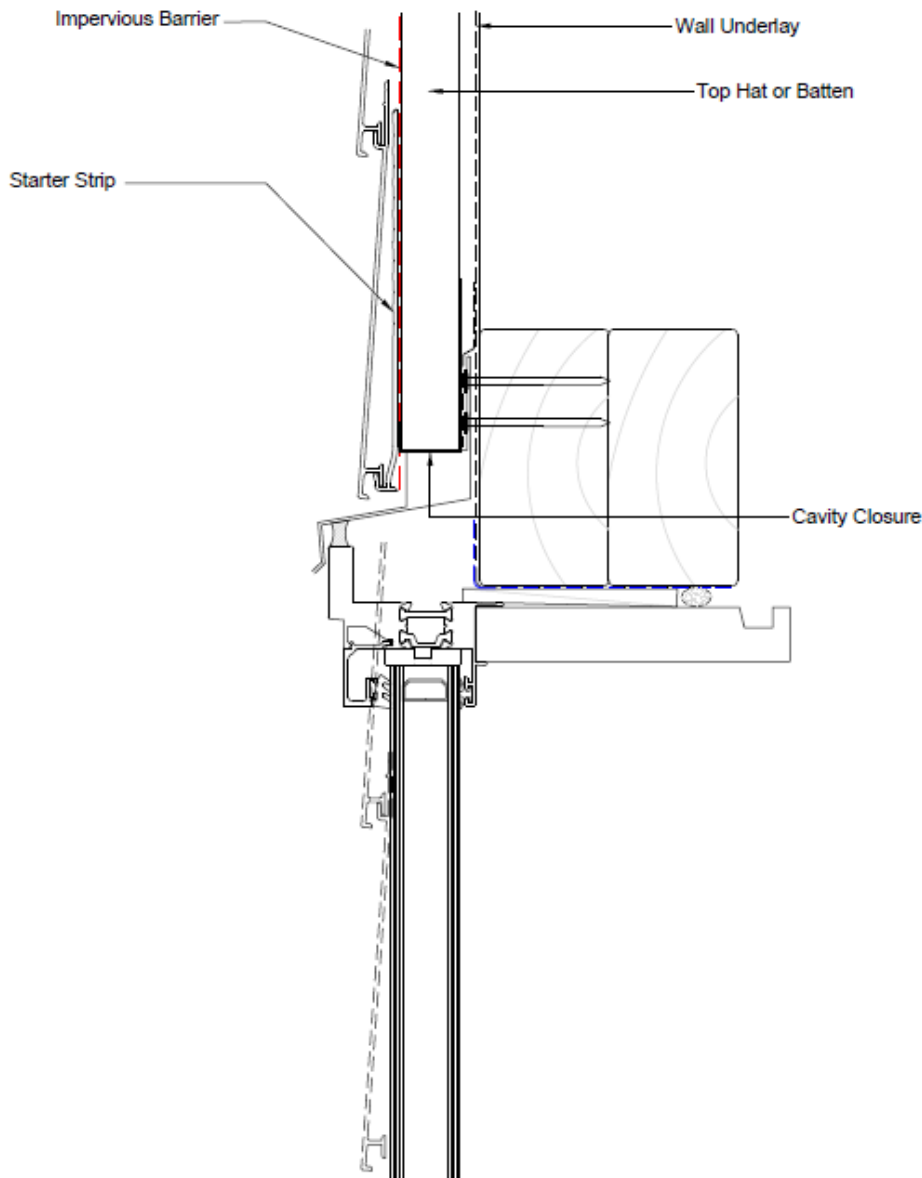

Horizontal Cladding - Window Head Detail

Typical Horizontal Fixing Detail

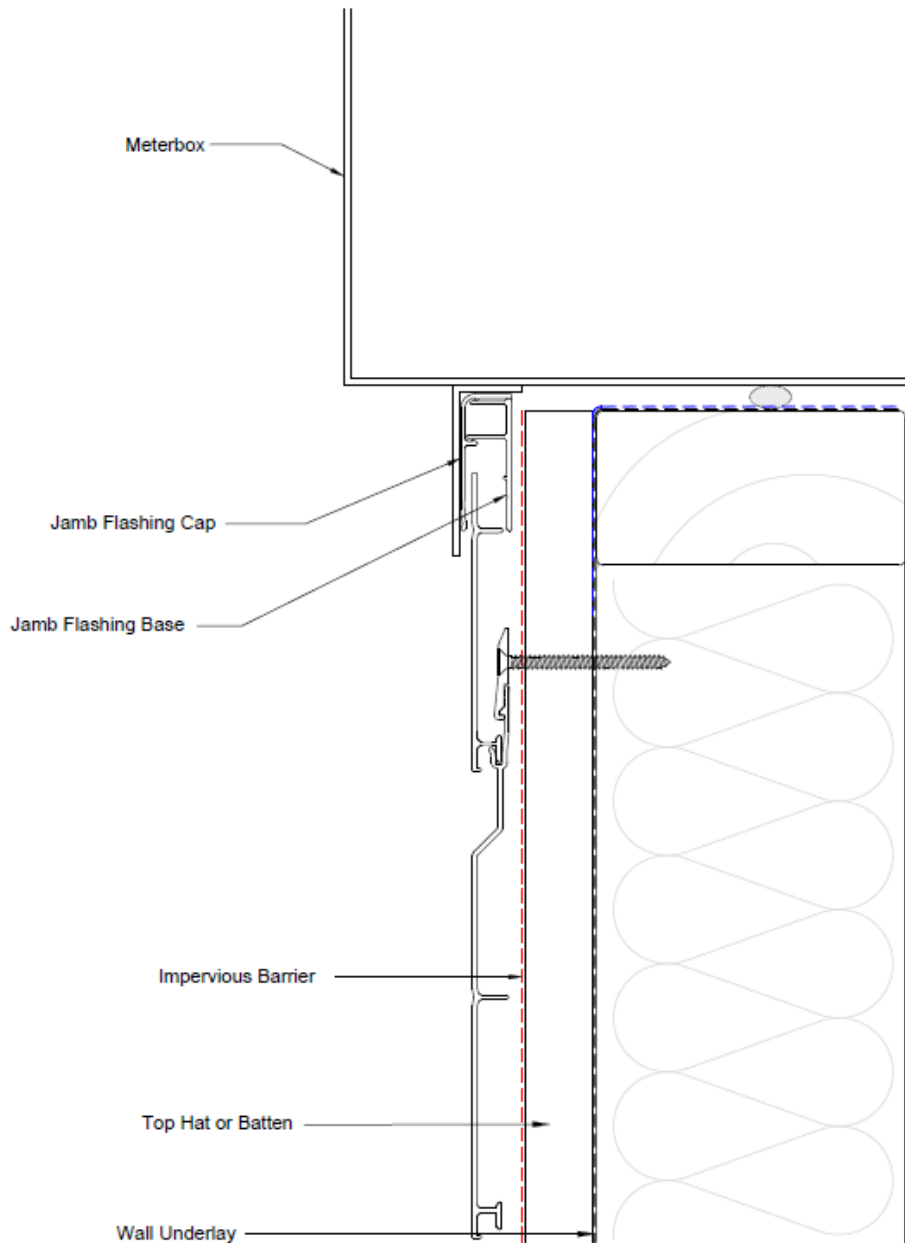

Horizontal Cladding - Meter Box Sill Detail

Typical Horizontal Fixing Detail

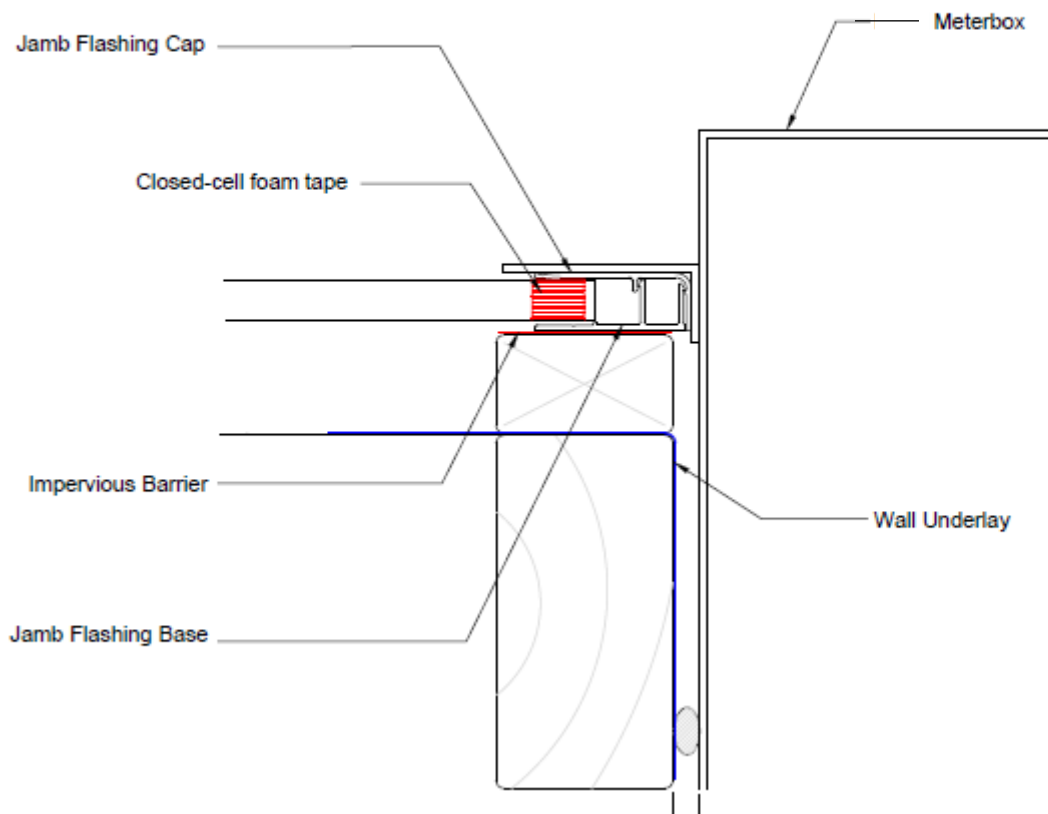

Horizontal Cladding - Meter Box Jamb Detail

Typical Horizontal Fixing Detail

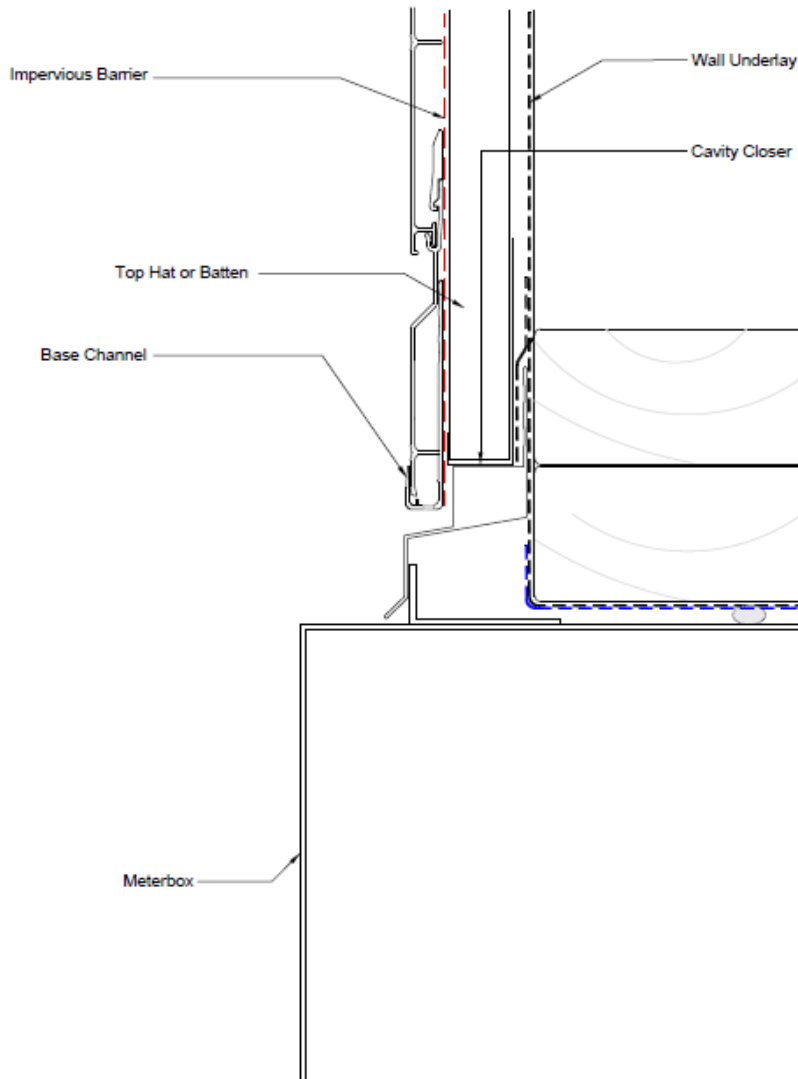

Horizontal Cladding Meter Box Head Detail

Typical Horizontal Fixing Detail

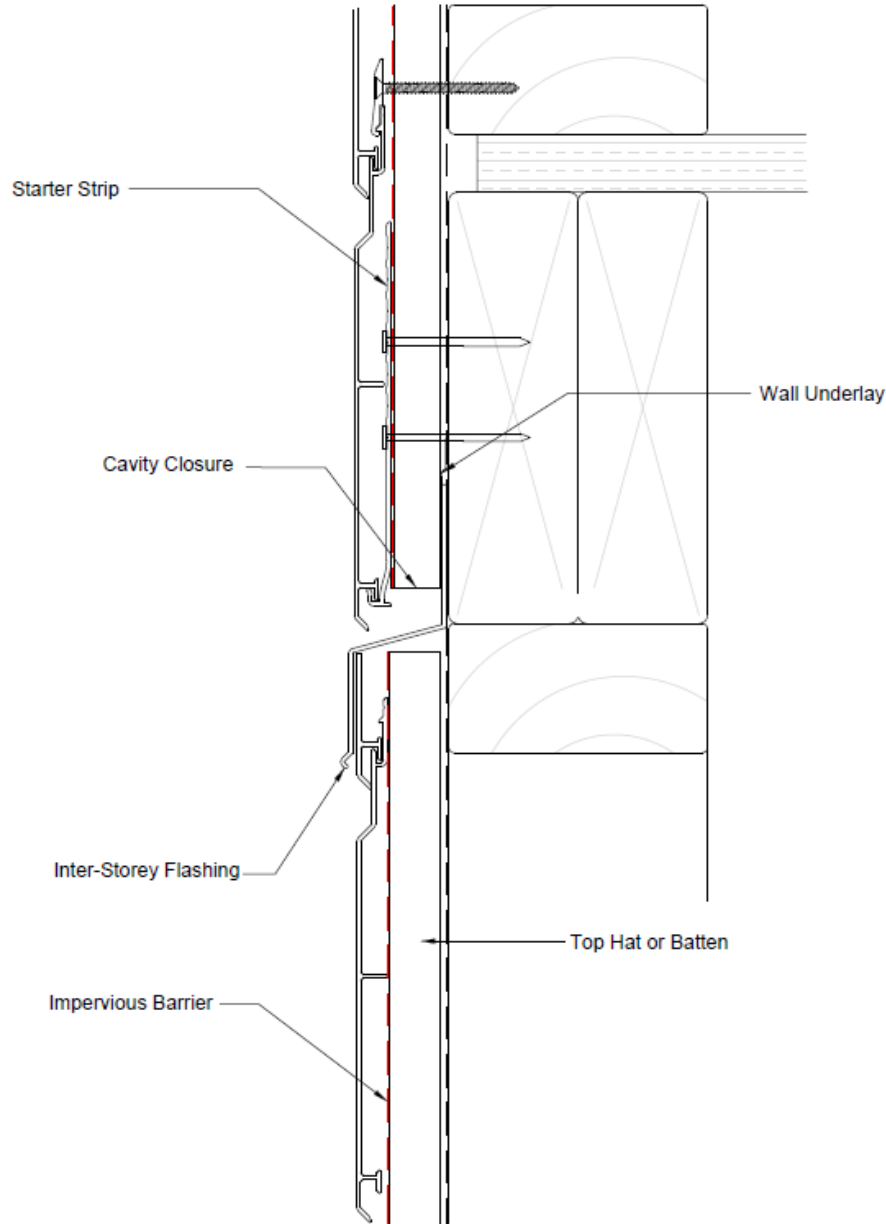

Horizontal Cladding Inter-Storey Joint

Typical Horizontal Fixing Detail

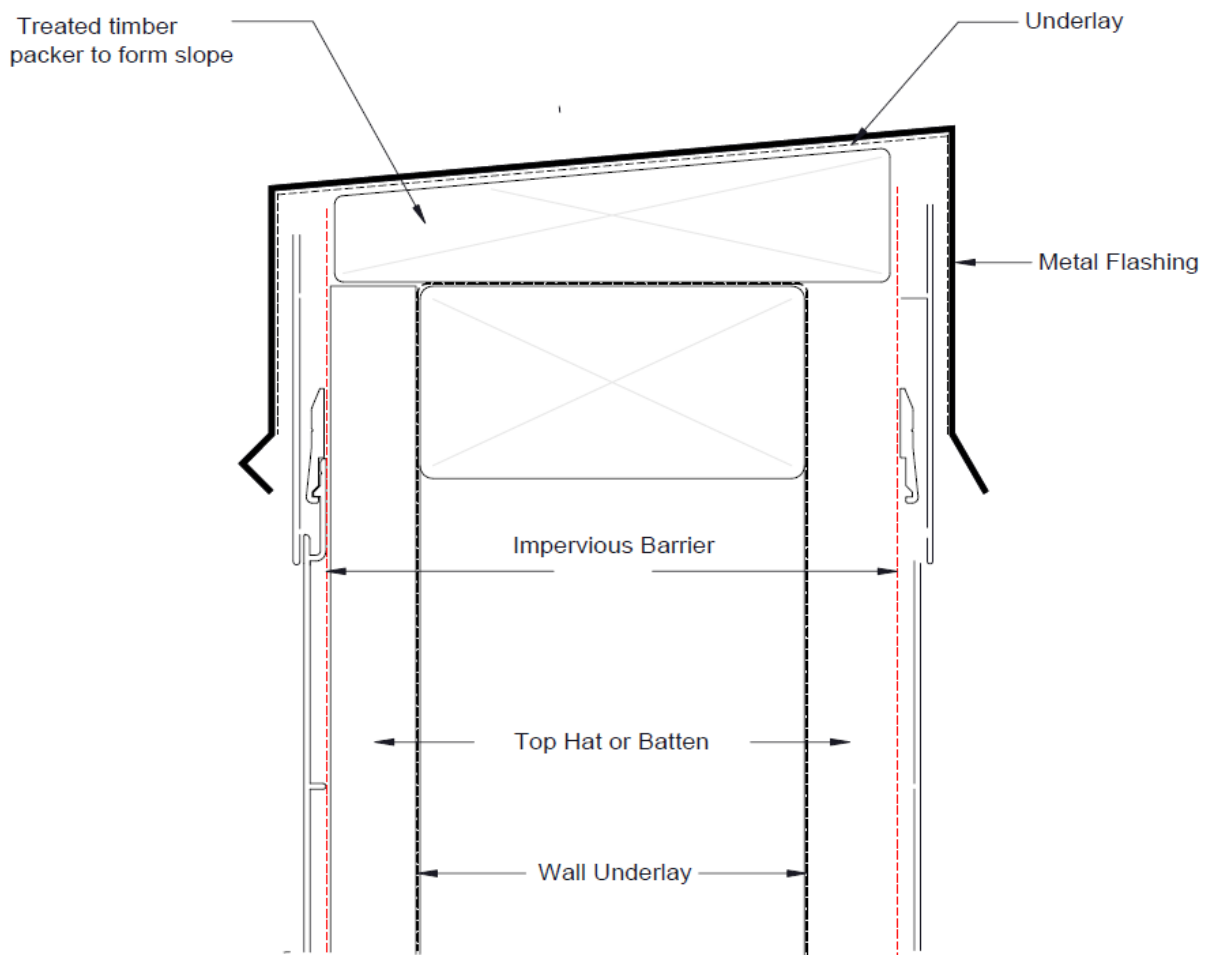

Horizontal Cladding - Parapet Flashing

Typical Horizontal Fixing Detail

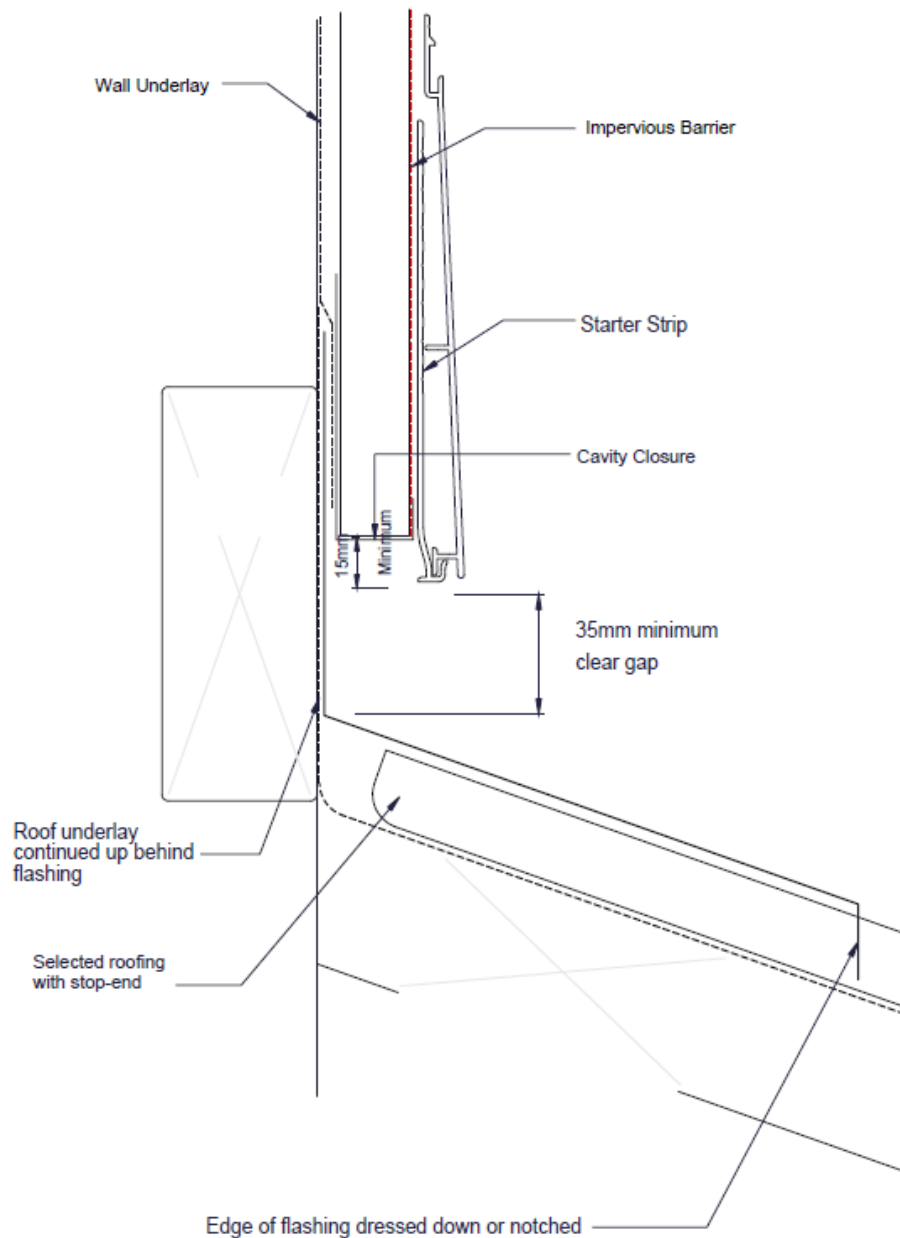

Horizontal Cladding Roof / Wall Junction